

SCHRAUBEN DRUCKFEDERN ELASTOMER FEDERN

INHALTSVERZEICHNIS

	Seite
FEDERN FÜR LEICHTE BELASTUNG	5.02
FEDERN FÜR MITTLERE BELASTUNG	5.04
FEDERN FÜR SCHWERE BELASTUNG	5.06
FEDERN FÜR BESONDERS SCHWERE BELASTUNG	5.08
FEDERHALTER	5.10
ELASTOMER STÄBE	5.11
ELASTOMER-FEDERN 70 Shore A	5.12
ELASTOMER-FEDERN 90 Shore A	5.14
ZUBEHÖR FÜR ELASTOMER-FEDERN	5.16

10 - 16 mm Hüsendurchmesser
Runder Drahtquerschnitt

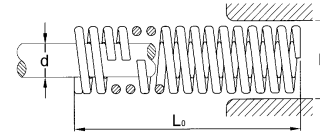

Ø Hülsen mm	Ø Dorn mm	Unbel. Länge mm	Bestell-Nr	Erforderliche daN um Feder 1 mm zu drücken	FEDERWEGE							
					Für lange Lebensdauer (25% von Lo)		Für mittlere Lebensdauer (30% von Lo)		Max. Belastbarkeit bei $f_n = 40\%$ von Lo		Federweg bis Blockhöhe	
					Kraft daN	Federweg mm	Kraft daN	Federweg mm	Kraft daN	Federweg mm	Kraft daN	Federweg mm
D	d	Lo		C								
10	5	25	F.10025.1	0,45	2,8	6,2	3,4	7,5	4,6	10,2	5,8	13
		32	F.10032.1	0,35	2,8	8	3,4	9,6	4,4	12,5	5,6	16
		38	F.10038.1	0,28	2,7	9,5	3,1	11	4,2	15	5,6	20
		44	F.10044.1	0,24	2,6	11	3,1	13	4,3	18	5,6	23
		51	F.10051.1	0,21	2,7	13	3,1	15	4,2	20	5,6	27
		64	F.10064.1	0,16	2,6	16	3	19	4	25	5,5	34
		76	F.10076.1	0,13	2,5	19	3	23	3,9	30	5,3	40
12,5	6,3	25	F.12025.1	0,89	5,5	6,2	6,7	7,5	9,1	10,2	11,6	13
		32	F.12032.1	0,67	5,4	8	6,4	9,6	8,4	12,5	11,4	17
		38	F.12038.1	0,55	5,2	9,5	6,1	11	8,3	15	11	20
		44	F.12044.1	0,46	5,1	11	6	13	8,3	18	10,6	23
		51	F.12051.1	0,39	5,1	13	5,9	15	7,8	20	10,5	27
		64	F.12064.1	0,30	4,8	16	5,7	19	7,5	25	10,5	35
		76	F.12076.1	0,25	4,8	19	5,7	23	7,5	30	10,3	41
16	8	25	F.16025.1	1,79	11,1	6,2	13,4	7,5	18,3	10,2	23	13
		32	F.16032.1	1,34	10,7	8	12,9	9,6	16,8	12,5	21	16
		38	F.16038.1	1,06	10,1	9,5	11,7	11	15,9	15	21	20
		44	F.16044.1	0,87	9,6	11	11,3	13	15,7	18	20	23
		51	F.16051.1	0,76	9,9	13	11,4	15	15,2	20	20	27
		64	F.16064.1	0,59	9,4	16	11,2	19	14,8	25	20	34
		76	F.16076.1	0,48	9,1	19	11	23	14,4	30	19,7	41
16	8	89	F.16089.1	0,40	8,8	22	10,8	27	14	35	19,6	49
		102	F.16102.1	0,35	9,1	26	10,8	31	14,3	41	19,6	56
		305	F.16305.1	0,11	8,4	76	10	91	13,4	122	18,7	170

20 mm Hüsendurchmesser
Rechteckiger Drahtquerschnitt

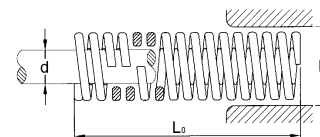

Ø Hülsen mm	Ø Dorn mm	Unbel. Länge mm	Bestell-Nr	Erforderliche daN um Feder 1 mm zu drücken	FEDERWEGE							
					Für lange Lebensdauer (25% von Lo)		Für mittlere Lebensdauer (30% von Lo)		Max. Belastbarkeit bei $f_n = 40\%$ von Lo		Federweg bis Blockhöhe	
					Kraft daN	Federweg mm	Kraft daN	Federweg mm	Kraft daN	Federweg mm	Kraft daN	Federweg mm
D	d	Lo		C								
20	10	25	F.20025.1	5,5	35	6,2	42	7,5	57	10,2	73	13
		32	F.20032.1	4,2	34	8	41	9,6	54	12,5	69	16
		38	F.20038.1	3,3	32	9,5	37	11	51	15	65	19
		44	F.20044.1	2,77	31	11	37	13	51	18	64	23
		51	F.20051.1	2,45	32	13	37	15	50	20	64	26
		64	F.20064.1	1,90	31	16	37	19	49	25	62	32
		76	F.20076.1	1,61	31	19	37	23	48	30	62	40
		89	F.20089.1	1,34	30	22	36	27	47	35	62	46
		102	F.20102.1	1,18	31	26	37	31	48	41	62	53
		115	F.20115.1	1,04	30	29	36	35	48	46	62	60
		127	F.20127.1	0,93	30	32	35	38	47	51	62	67
		140	F.20140.1	0,85	30	35	36	42	48	56	62	73
		152	F.20152.1	0,79	30	38	36	46	48	61	62	81
		305	F.20305.1	0,38	29	76	35	91	46	122	61	162

25 - 63 mm Hüsendurchmesser
Rechteckiger Drahtquerschnitt (Fortsetzung)

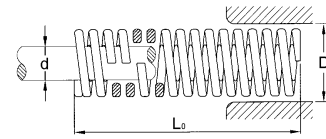

Ø Hülsen mm	Ø Dorn mm	Unbel. Länge mm	Bestell-Nr	Erforderliche daN um Feder 1 mm zu drücken	FEDERWEGE								
					Für lange Lebensdauer (25% von L ₀)		Für mittlere Lebensdauer (30% von L ₀)		Max. Belastbarkeit bei f _n = 40% von L ₀		Federweg bis Blockhöhe		
					Kraft daN	Federweg mm	Kraft daN	Federweg mm	Kraft daN	Federweg mm	Kraft daN	Federweg mm	
D	d	L₀	C										
25	12,5	25	F.25025.1	10,7	66	6,2	80	7,5	109	10,2	139	13	
		32	F.25032.1	8,1	65	8	78	9,6	101	12,5	130	16	
		38	F.25038.1	6,5	62	9,5	72	11	98	15	124	19	
		44	F.25044.1	5,3	58	11	69	13	95	18	122	23	
		51	F.25051.1	4,6	60	13	69	15	92	20	115	25	
		64	F.25064.1	3,6	58	16	68	19	90	25	112	31	
		76	F.25076.1	2,92	56	19	67	23	88	30	112	39	
		89	F.25089.1	2,46	54	22	66	27	86	35	112	46	
		102	F.25102.1	2,12	55	26	66	31	87	41	110	52	
		115	F.25115.1	1,87	54	29	65	35	86	46	110	59	
		127	F.25127.1	1,67	53	32	63	38	85	51	110	66	
		140	F.25140.1	1,52	53	35	64	42	85	56	112	74	
		152	F.25152.1	1,40	53	38	64	46	85	61	110	80	
		178	F.25178.1	1,20	53	44	64	53	85	71	110	93	
		203	F.25203.1	1,05	53	51	64	61	85	81	110	107	
		305	F.25305.1	0,70	53	76	64	91	85	122	110	160	
		32	16	38	F.32038.1	10,1	96	9,5	111	11	152	15	192
44	F.32044.1			8,3	91	11	108	13	149	18	183	22	
51	F.32051.1			7,1	92	13	107	15	142	20	178	25	
64	F.32064.1			5,5	88	16	105	19	138	25	176	32	
76	F.32076.1			4,6	87	19	106	23	138	30	175	39	
89	F.32089.1			3,9	86	22	105	27	137	35	175	45	
102	F.32102.1			3,4	88	26	105	31	139	41	175	52	
115	F.32115.1			3,0	87	29	105	35	138	46	174	58	
127	F.32127.1			2,62	84	32	100	38	134	51	170	65	
140	F.32140.1			2,38	83	35	100	42	133	56	171	72	
152	F.32152.1			2,19	83	38	101	46	134	61	170	78	
178	F.32178.1			1,82	80	44	96	53	129	71	165	88	
203	F.32203.1			1,59	81	51	97	61	129	81	165	104	
254	F.32254.1			1,25	80	64	95	76	128	102	163	130	
305	F.32305.1	1,04	79	76	95	91	127	122	161	155			
40	20	51	F.40051.1	10,6	138	13	159	15	212	20	265	25	
		64	F.40064.1	8,0	128	16	152	19	200	25	256	32	
		76	F.40076.1	6,6	125	19	152	23	198	30	250	38	
		89	F.40089.1	5,6	123	22	151	27	196	35	250	45	
		102	F.40102.1	4,8	125	26	149	31	197	41	245	51	
		115	F.40115.1	4,2	122	29	147	35	193	46	243	58	
		127	F.40127.1	3,8	122	32	144	38	194	51	243	65	
		140	F.40140.1	3,4	119	35	143	42	190	56	241	71	
		152	F.40152.1	3,1	118	38	143	46	189	61	241	78	
		178	F.40178.1	2,6	114	44	138	53	185	71	240	92	
		203	F.40203.1	2,3	117	51	140	61	186	81	240	105	
		254	F.40254.1	1,80	115	64	137	76	184	102	236	131	
		305	F.40305.1	1,48	112	76	135	91	181	122	226	157	
50	25	64	F.50064.1	15,7	251	16	298	19	393	25	502	32	
		76	F.50076.1	12,6	239	19	290	23	378	30	491	39	
		89	F.50089.1	10,5	231	22	284	27	368	35	473	45	
		102	F.50102.1	9,0	234	26	279	31	369	41	468	52	
		115	F.50115.1	7,8	226	29	273	35	359	46	455	58	
		127	F.50127.1	7,0	224	32	266	38	357	51	455	65	
		140	F.50140.1	6,3	221	35	265	42	353	56	446	72	
		152	F.50152.1	5,7	217	38	262	46	348	61	445	78	
		178	F.50178.1	4,8	211	44	254	53	341	71	441	92	
		203	F.50203.1	4,2	214	51	256	61	340	81	437	104	
		254	F.50254.1	3,3	211	64	251	76	337	102	429	130	
305	F.50305.1	2,7	205	76	246	91	329	122	421	156			
63	38	76	F.63076.1	19,3	367	19	444	23	579	30	733	38	
		89	F.63089.1	15,8	348	22	427	27	553	35	695	44	
		102	F.63102.1	13,4	348	26	415	31	549	41	670	50	
		115	F.63115.1	11,6	336	29	406	35	534	46	661	57	
		127	F.63127.1	10,2	326	32	388	38	520	51	653	64	
		152	F.63152.1	8,4	319	38	386	46	512	61	638	76	
		178	F.63178.1	7,0	308	44	371	53	497	71	623	89	
		203	F.63203.1	6,0	306	51	366	61	486	81	612	102	
		254	F.63254.1	4,7	301	64	357	76	479	102	592	126	
		305	F.63305.1	3,9	296	76	355	91	476	122	592	152	

10 - 16 mm Hüsendurchmesser
Runder Drahtquerschnitt

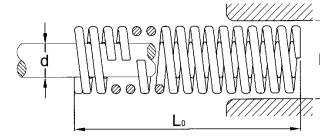

Ø Hülsen mm	Ø Dorn mm	Unbel. Länge mm	Bestell-Nr	Erforderliche daN um Feder 1 mm zu drücken	FEDERWEGE							
					Für lange Lebensdauer (25% von Lo)		Für mittlere Lebensdauer (30% von Lo)		Max. Belastbarkeit bei $f_n = 37,5\%$ von Lo		Federweg bis Blockhöhe	
					C	Kraft daN	Federweg mm	Kraft daN	Federweg mm	Kraft daN	Federweg mm	Kraft daN
10	5	25	F.10025.2	1,26	7,8	6,2	9,5	7,5	11,8	9,4	13	11
		32	F.10032.2	0,98	7,8	8	9,4	9,6	11,8	12	12,8	13
		38	F.10038.2	0,79	7,5	9,5	8,7	11	11,1	14	12,6	16
		44	F.10044.2	0,66	7,3	11	8,6	13	10,9	16,5	12,5	19
		51	F.10051.2	0,57	7,4	13	8,6	15	10,8	19	12,2	21
		64	F.10064.2	0,45	7,2	16	8,6	19	10,8	24	12,2	27
		76	F.10076.2	0,37	7	19	8,5	23	10,4	28	12,2	33
		305	F.10305.2	0,09	6,8	76	8,2	91	10,3	114	12,2	136
12,5	6,3	25	F.12025.2	2,28	14,1	6,2	17,1	7,5	21,4	9,4	23	11
		32	F.12032.2	1,75	14	8	16,8	9,6	21	12	22,8	13
		38	F.12038.2	1,43	13,6	9,5	15,7	11	20	14	22,8	16
		44	F.12044.2	1,18	13	11	15,3	13	19,5	16,5	22,5	19
		51	F.12051.2	1,02	13,3	13	15,3	15	19,4	19	22,4	22
		64	F.12064.2	0,79	12,6	16	15	19	19	24	22,1	28
		76	F.12076.2	0,65	12,4	19	15	23	18,2	28	22	34
		89	F.12089.2	0,55	12,1	22	14,9	27	18,2	33	22,6	41
		305	F.12305.2	0,15	11,4	76	13,7	91	17,1	114	21,6	144
16	8	25	F.16025.2	3,38	20,6	6,2	25,4	7,5	31,8	9,4	33,8	11
		32	F.16032.2	2,50	20	8	24	9,6	30	12	32,8	13
		38	F.16038.2	2,01	19,1	9,5	22,1	11	28,1	14	32,2	16
		44	F.16044.2	1,67	18,4	11	21,7	13	27,6	16,5	30,9	19
		51	F.16051.2	1,42	18,5	13	21,3	15	27	19	30	21
		64	F.16064.2	1,10	17,6	16	20,9	19	26,4	24	29,7	27
		76	F.16076.2	0,90	17,1	19	20,7	23	25,2	28	29,7	33
		89	F.16089.2	0,76	16,7	22	20,5	27	25,1	33	29,6	39
		102	F.16102.2	0,66	17,2	26	20,5	31	25,1	38	29,6	45
		305	F.16305.2	0,21	16	76	19,1	91	23,9	114	29	138

20 mm Hüsendurchmesser
Rechteckiger Drahtquerschnitt

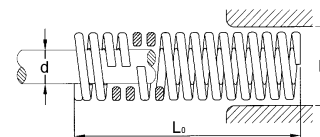

Ø Hülsen mm	Ø Dorn mm	Unbel. Länge mm	Bestell-Nr	Erforderliche daN um Feder 1 mm zu drücken	FEDERWEGE							
					Für lange Lebensdauer (25% von Lo)		Für mittlere Lebensdauer (30% von Lo)		Max. Belastbarkeit bei $f_n = 37,5\%$ von Lo		Federweg bis Blockhöhe	
					C	Kraft daN	Federweg mm	Kraft daN	Federweg mm	Kraft daN	Federweg mm	Kraft daN
20	10	25	F.20025.2	9,02	55,9	6,2	67,6	7,5	84,8	9,4	99	11
		32	F.20032.2	6,67	53,4	8	64	9,6	80	12	90	13
		38	F.20038.2	5,48	52,1	9,5	60,3	11	76,7	14	88	16
		44	F.20044.2	4,45	49	11	57,9	13	73,4	16,5	85	19
		51	F.20051.2	3,94	51,2	13	59,1	15	74,9	19	83	21
		64	F.20064.2	3,03	48,5	16	57,6	19	72,7	24	82	27
		76	F.20076.2	2,49	47,3	19	57,3	23	69,7	28	82	33
		89	F.20089.2	2,14	47,1	22	57,8	27	70,6	33	82	39
		102	F.20102.2	1,84	47,8	26	57	31	69,9	38	81	44
		115	F.20115.2	1,63	47,3	29	57	35	70,1	43	80	49
		127	F.20127.2	1,46	46,7	32	55,5	38	70,1	48	80	55
		140	F.20140.2	1,32	46	35	55	42	69	52	80	61
		152	F.20152.2	1,21	46	38	55,7	46	69	57	80	66
		305	F.20305.2	0,61	46,4	76	55,5	91	69,5	114	80	136

25 - 63 mm Hüsendurchmesser
Rechteckiger Drahtquerschnitt (Fortsetzung)

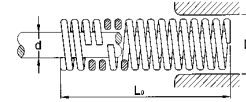

Ø Hülsen mm	Ø Dorn mm	Unbel. Länge mm	Bestell-Nr	Erforderliche daN um Feder 1 mm zu drücken	FEDERWEGE									
					Für lange Lebensdauer (25% von Lo)		Für mittlere Lebensdauer (30% von Lo)		Max. Belastbarkeit bei $f_n = 37,5\%$ von Lo		Federweg bis Blockhöhe			
					Kraft daN	Federweg mm	Kraft daN	Federweg mm	Kraft daN	Federweg mm	Kraft daN	Federweg mm		
D	d	Lo	C											
25	12,5	25	F.25025.2	16,7	104	6,2	125	7,5	157	9,4	184	11		
		32	F.25032.2	12,5	100	8	120	9,6	150	12	170	13		
		38	F.25038.2	9,9	94	9,5	109	11	139	14	158	16		
		44	F.25044.2	8,3	91	11	108	13	137	16,5	158	19		
		51	F.25051.2	7,2	94	13	108	15	137	19	156	21		
		64	F.25064.2	5,5	88	16	105	19	132	24	151	27		
		76	F.25076.2	4,5	86	19	104	23	126	28	148	33		
		89	F.25089.2	3,8	84	22	103	27	125	33	148	39		
		102	F.25102.2	3,3	86	26	102	31	125	38	145	44		
		115	F.25115.2	2,91	84	29	102	35	125	43	145	60		
		127	F.25127.2	2,63	84	32	100	38	126	48	145	66		
		140	F.25140.2	2,36	83	35	99	42	123	52	149	63		
		152	F.25152.2	2,17	82	38	100	46	124	57	145	67		
		178	F.25178.2	1,84	81	44	98	53	123	67	145	79		
		203	F.25203.2	1,60	82	51	98	61	122	76	144	90		
		305	F.25305.2	1,05	80	76	96	91	120	114	142	135		
32	16	38	F.32038.2	16,6	158	9,5	183	11	232	14	266	16		
		44	F.32044.2	13,6	150	11	177	13	224	16,5	258	19		
		51	F.32051.2	11,6	151	13	174	15	220	19	244	21		
		64	F.32064.2	8,8	141	16	167	19	211	24	238	27		
		76	F.32076.2	7,1	135	19	163	23	199	28	227	32		
		89	F.32089.2	6,0	132	22	162	27	198	33	222	37		
		102	F.32102.2	5,2	135	26	161	31	198	38	222	43		
		115	F.32115.2	4,6	133	29	161	35	198	43	222	49		
		127	F.32127.2	4,2	134	32	160	38	202	48	222	55		
		140	F.32140.2	3,7	130	35	155	42	192	52	222	60		
		152	F.32152.2	3,4	129	38	156	46	194	57	222	66		
		178	F.32178.2	2,91	128	44	154	53	195	67	222	77		
		203	F.32203.2	2,52	129	51	154	61	192	76	222	88		
		254	F.32254.2	2,00	128	64	152	76	190	95	220	110		
		305	F.32305.2	1,66	126	76	151	91	189	114	220	133		
		40	20	51	F.40051.2	17,1	222	13	257	15	325	19	359	21
64	F.40064.2			12,9	206	16	245	19	310	24	335	26		
76	F.40076.2			10,5	200	19	242	23	294	28	335	32		
89	F.40089.2			8,8	194	22	238	27	290	33	326	37		
102	F.40102.2			7,6	198	26	236	31	289	38	326	43		
115	F.40115.2			6,7	194	29	235	35	288	43	322	48		
127	F.40127.2			6,0	192	32	228	38	288	48	322	54		
140	F.40140.2			5,4	189	35	227	42	281	52	319	59		
152	F.40152.2			4,9	186	38	225	46	279	57	318	65		
178	F.40178.2			4,2	185	44	223	53	281	67	318	76		
203	F.40203.2			3,6	184	51	220	61	274	76	315	87		
254	F.40254.2			2,89	185	64	220	76	275	95	315	110		
305	F.40305.2			2,38	181	76	217	91	271	114	312	131		
50	25			64	F.50064.2	21,2	339	16	403	19	509	24	566	27
				76	F.50076.2	16,7	317	19	384	23	468	28	532	32
				89	F.50089.2	14,0	308	22	378	27	462	33	525	37
		102	F.50102.2	12,2	317	26	378	31	464	38	525	43		
		115	F.50115.2	10,7	310	29	375	35	460	43	525	49		
		127	F.50127.2	9,5	304	32	361	38	456	48	513	54		
		140	F.50140.2	8,6	301	35	361	42	447	52	507	59		
		152	F.50152.2	7,8	296	38	359	46	445	57	508	66		
		178	F.50178.2	6,6	290	44	350	53	442	67	506	77		
		203	F.50203.2	5,7	291	51	348	61	433	76	506	88		
		229	F.50229.2	5,1	291	57	352	69	439	86	506	100		
		254	F.50254.2	4,6	294	64	350	76	437	95	506	117		
		305	F.50305.2	3,8	289	76	346	91	433	114	504	134		
		63	38	76	F.63076.2	30,4	578	19	699	23	851	28	973	32
				89	F.63089.2	25,0	550	22	675	27	825	33	950	38
				102	F.63102.2	21,2	551	26	657	31	806	38	933	44
115	F.63115.2			18,6	539	29	651	35	800	43	930	50		
127	F.63127.2			16,4	525	32	623	38	787	48	918	56		
152	F.63152.2			13,3	505	38	612	46	758	57	891	67		
178	F.63178.2			11,2	493	44	594	53	750	67	874	78		
203	F.63203.2			9,6	490	51	586	61	730	76	865	90		
229	F.63229.2			8,5	485	57	587	69	731	86	865	102		
254	F.63254.2			7,7	493	64	585	76	732	95	865	115		
305	F.63305.2			6,3	479	76	573	91	718	114	865	138		

10 - 16 mm Hüsendurchmesser
Runder Drahtquerschnitt

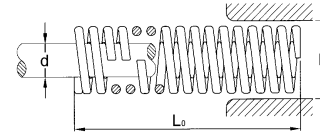

Ø Hülsen mm	Ø Dorn mm	Unbel. Länge mm	Bestell-Nr	Erforderliche daN um Feder 1 mm zu drücken	FEDERWEGE							
					Für lange Lebensdauer (20% von Lo)		Für mittlere Lebensdauer (25% von Lo)		Max. Belastbarkeit bei $f_n = 30\%$ von Lo		Federweg bis Blockhöhe	
D	d	Lo	C	Kraft daN	Federweg mm	Kraft daN	Federweg mm	Kraft daN	Federweg mm	Kraft daN	Federweg mm	
10	5	25	F.10025.3	2,13	10,5	5	13	6,2	16	7,5	19	8,9
		32	F.10032.3	1,64	10,5	6,5	13	8	15,5	9,6	19	11,7
		38	F.10038.3	1,33	10	7,5	12,5	9,5	14,5	11	18,5	14
		44	F.10044.3	1,13	10	9	12,5	11	14,5	13	18,5	17
		51	F.10051.3	0,98	10	10	12,5	13	14,5	15	18,5	19
		64	F.10064.3	0,78	10	13	12,5	16	14,5	19	18,5	25
		76	F.10076.3	0,63	10	15	12	19	14,5	23	18	29
		305	F.10305.3	0,15	9	61	11,5	76	13,5	91	18	120
12,5	6,3	25	F.12025.3	3,9	19,5	5	24	6,2	29	7,5	34	8,7
		32	F.12032.3	3,0	19,5	6,5	24	8	29	9,6	33	11
		38	F.12038.3	2,42	18	7,5	23	9,5	27	11	32	13,5
		44	F.12044.3	2,01	18	9	22	11	26	13	32	16
		51	F.12051.3	1,77	18	10	23	13	27	15	32	19
		64	F.12064.3	1,38	18	13	22	16	26	19	32	24
		76	F.12076.3	1,14	17	15	21,5	19	26	23	32	29
		89	F.12089.3	0,96	17,3	18	21,1	22	25,9	27	32	33
		305	F.12305.3	0,27	16,5	61	20,5	76	24,5	91	32	120
16	8	25	F.16025.3	8,7	44	5	54	6,2	65	7,5	76	8,7
		32	F.16032.3	6,4	42	6,5	51	8	61	9,6	70	11
		38	F.16038.3	5,2	39	7,5	49	9,5	57	11	70	13,7
		44	F.16044.3	4,2	38	9	46	11	55	13	66	15,7
		51	F.16051.3	3,64	36	10	47	13	55	15	66	18,5
		64	F.16064.3	2,84	37	13	45	16	54	19	66	23,5
		76	F.16076.3	2,33	35	15	44	19	54	23	66	29
		89	F.16089.3	1,98	36	18	44	22	53	27	66	34,5
		102	F.16102.3	1,72	34	20	45	26	53	31	66	40
		305	F.16305.3	0,54	33	61	41	76	49	91	66	122

20 mm Hüsendurchmesser
Rechteckiger Drahtquerschnitt

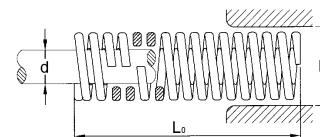

Ø Hülsen mm	Ø Dorn mm	Unbel. Länge mm	Bestell-Nr	Erforderliche daN um Feder 1 mm zu drücken	FEDERWEGE							
					Für lange Lebensdauer (20% von Lo)		Für mittlere Lebensdauer (25% von Lo)		Max. Belastbarkeit bei $f_n = 30\%$ von Lo		Federweg bis Blockhöhe	
D	d	Lo	C	Kraft daN	Federweg mm	Kraft daN	Federweg mm	Kraft daN	Federweg mm	Kraft daN	Federweg mm	
20	10	25	F.20025.3	23,1	116	5	143	6,2	173	7,5	194	8,4
		32	F.20032.3	17,4	113	6,5	139	8	167	9,6	183	10,5
		38	F.20038.3	13,9	106	7,5	132	9,5	153	11	174	12,5
		44	F.20044.3	11,4	103	9	127	11	148	13	165	14,5
		51	F.20051.3	9,8	101	10	127	13	147	15	162	16,5
		64	F.20064.3	7,7	100	13	128	16	146	19	162	21
		76	F.20076.3	6,3	97	15	120	19	145	23	162	26
		89	F.20089.3	5,4	97	18	120	22	145	27	162	30
		102	F.20102.3	4,7	94	20	120	26	145	31	162	35
		115	F.20115.3	4,1	94	23	119	29	144	35	162	40
		127	F.20127.3	3,7	93	25	118	32	141	38	162	44
		140	F.20140.3	3,4	95	28	119	35	143	42	167	49
		152	F.20152.3	3,08	92	30	117	38	141	46	162	53
		305	F.20305.3	1,50	91	61	114	76	137	91	162	108

25 - 50 mm Hüsendurchmesser
Rechteckiger Drahtquerschnitt (Fortsetzung)

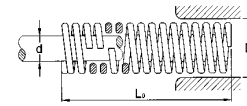

Ø Hülsen mm	Ø Dorn mm	Unbel. Länge mm	Bestell-Nr	Erforderliche daN um Feder 1 mm zu drücken	FEDERWEGE							
					Für lange Lebensdauer (20% von L ₀)		Für mittlere Lebensdauer (25% von L ₀)		Max. Belastbarkeit bei f _n = 30% von L ₀		Federweg bis Blockhöhe	
					Kraft daN	Federweg mm	Kraft daN	Federweg mm	Kraft daN	Federweg mm	Kraft daN	Federweg mm
25	12,5	32	F.25032.3	27,6	179	6,5	221	8	265	9,6	290	10,5
		38	F.25038.3	22,0	165	7,5	209	9,5	242	11	286	13
		44	F.25044.3	18,4	166	9	202	11	239	13	285	15,5
		51	F.25051.3	15,7	157	10	204	13	236	15	283	18
		64	F.25064.3	12,2	159	13	195	16	232	19	275	22,5
		76	F.25076.3	10,0	150	15	190	19	230	23	275	27,5
		89	F.25089.3	8,4	151	18	185	22	227	27	275	32,5
		102	F.25102.3	7,4	148	20	192	26	229	31	275	37,5
		115	F.25115.3	6,5	150	23	189	29	228	35	275	42,7
		127	F.25127.3	5,8	145	25	186	32	220	38	273	47
		140	F.25140.3	5,2	146	28	182	35	218	42	270	52
		152	F.25152.3	4,8	144	30	182	38	221	46	273	57,5
		178	F.25178.3	4,1	148	36	180	44	217	53	273	68
		203	F.25203.3	3,59	144	40	183	51	219	61	273	77
305	F.25305.3	2,42	148	61	184	76	220	91	273	115		
32	16	38	F.32038.3	37,6	282	7,5	357	9,5	414	11	451	12
		44	F.32044.3	31,0	279	9	341	11	403	13	440	14
		51	F.32051.3	26,3	263	10	342	13	394	15	435	16,5
		64	F.32064.3	20,5	267	13	328	16	389	19	435	21,5
		76	F.32076.3	16,6	249	15	315	19	382	23	430	26
		89	F.32089.3	13,9	250	18	306	22	375	27	425	30,5
		102	F.32102.3	12,1	242	20	315	26	375	31	425	35,5
		115	F.32115.3	10,6	244	23	307	29	371	35	425	40,5
		127	F.32127.3	9,6	240	25	307	32	365	38	425	45
		140	F.32140.3	8,6	241	28	301	35	361	42	430	50
		152	F.32152.3	7,9	237	30	300	38	363	46	425	54
		178	F.32178.3	6,7	241	36	295	44	355	53	420	63
		203	F.32203.3	5,8	232	40	296	51	354	61	420	72
		254	F.32254.3	4,6	235	51	294	64	350	76	420	92
305	F.32305.3	3,8	232	61	289	76	346	91	420	110		
40	20	51	F.40051.3	34,9	349	10	454	13	524	15	593	17
		64	F.40064.3	26,6	346	13	426	16	505	19	585	22
		76	F.40076.3	21,5	323	15	409	19	495	23	580	27
		89	F.40089.3	18,0	324	18	396	22	486	27	575	32
		102	F.40102.3	15,7	314	20	408	26	487	31	575	37
		115	F.40115.3	13,8	317	23	400	29	483	35	575	42
		127	F.40127.3	12,4	310	25	397	32	471	38	575	47
		140	F.40140.3	11,3	316	28	396	35	475	42	588	52
		152	F.40152.3	10,2	306	30	388	38	469	46	575	57,5
		178	F.40178.3	8,7	313	36	383	44	461	53	575	67
		203	F.40203.3	7,6	304	40	388	51	464	61	575	76
		254	F.40254.3	6,0	306	51	384	64	456	76	575	97
		305	F.40305.3	5,0	305	61	380	76	455	91	575	116
		50	25	64	F.50064.3	42,3	550	13	677	16	804	19
76	F.50076.3			33,8	507	15	642	19	777	23	879	26
89	F.50089.3			28,1	506	18	618	22	759	27	860	30,5
102	F.50102.3			24,5	490	20	637	26	760	31	860	35
115	F.50115.3			21,5	495	23	624	29	753	35	860	40
127	F.50127.3			18,9	473	25	605	32	718	38	850	45
140	F.50140.3			16,9	473	28	592	35	710	42	845	50
152	F.50152.3			15,4	462	30	585	38	708	46	830	54
178	F.50178.3			13,2	475	36	581	44	700	53	830	64
203	F.50203.3			11,5	460	40	587	51	701	61	830	72,5
254	F.50254.3			9,0	459	51	576	64	684	76	825	92
305	F.50305.3			7,5	457	61	570	76	683	91	825	112

10 - 20 mm Hüsendurchmesser
Rechteckiger Drahtquerschnitt

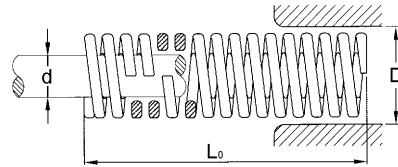

Ø Hülsen mm	Ø Dorn mm	Unbel. Länge mm	Bestell-Nr	Erforderliche daN um Feder 1 mm zu drücken	FEDERWEGE							
					Für lange Lebensdauer (17% von L ₀)		Für mittlere Lebensdauer (20% von L ₀)		Max. Belastbarkeit bei f _n = 25% von L ₀		Federweg bis Blockhöhe	
D	d	L ₀	C	Kraft daN	Federweg mm	Kraft daN	Federweg mm	Kraft daN	Federweg mm	Kraft daN	Federweg mm	
10	5	25	F.10025.4	3,27	13,7	4,2	16,4	5	20,3	6,2	29,5	8,7
		32	F.10032.4	2,50	13,8	5,5	16,3	6,5	20	8	27	10,5
		38	F.10038.4	2,12	13,8	6,5	15,2	7,5	20,1	9,5	27	13,2
		44	F.10044.4	1,77	13,3	7,5	15,9	9	19,5	11	26,5	15
		51	F.10051.4	1,53	13,3	8,7	15,3	10	19,9	13	26,5	17
		64	F.10064.4	1,22	13,4	11	15,9	13	19,5	16	26,5	21,5
		76	F.10076.4	1,01	13,1	13	15,2	15	19,2	19	26,5	26,5
		305	F.10305.4	0,25	13	52	15,3	61	19	76	26	106
12,5	6,3	25	F.12025.4	5,87	24,7	4,2	29,4	5	36,4	6,2	53	9
		32	F.12032.4	4,43	24,4	5,5	28,8	6,5	35,4	8	48	10,8
		38	F.12038.4	3,63	23,6	6,5	27,2	7,5	34,5	9,5	47	13
		44	F.12044.4	3,06	23	7,5	27,5	9	33,7	11	47	15,5
		51	F.12051.4	2,71	23,6	8,7	27,1	10	35,2	13	47	18
		64	F.12064.4	2,17	23,9	11	28,2	13	34,7	16	47	22
		76	F.12076.4	1,77	23	13	26,6	15	33,6	19	47	27
		89	F.12089.4	1,51	22,7	15	27,2	18	33	22	50	33
		305	F.12305.4	0,42	21,8	52	25,6	61	31,9	76	47	112
16	8	25	F.16025.4	12,6	53	4,2	63	5	78	6,2	113	9
		32	F.16032.4	9,3	51	5,5	60	6,5	74	8	103	10,8
		38	F.16038.4	7,5	49	6,5	56	7,5	71	9,5	98	13
		44	F.16044.4	6,3	47	7,5	57	9	69	11	96	15
		51	F.16051.4	5,5	48	8,7	55	10	72	13	96	18
		64	F.16064.4	4,3	47	11	56	13	69	16	95	22
		76	F.16076.4	3,52	46	13	53	15	67	19	94	26,5
		89	F.16089.4	3,00	45	15	54	18	66	22	94	31,5
				102	F.16102.4	2,61	44	17	52	20	68	26
		305	F.16305.4	0,85	44	52	52	61	65	76	94	110
20	10	25	F.20025.4	32,2	135	4,2	161	5	202	6,2	248	7,7
		32	F.20032.4	24,2	133	5,5	157	6,5	194	8	237	9,8
		38	F.20038.4	19,5	127	6,5	146	7,5	185	9,5	234	12
		44	F.20044.4	16,3	122	7,5	147	9	179	11	228	14
		51	F.20051.4	14,0	122	8,7	140	10	182	13	225	16
		64	F.20064.4	10,9	120	11	142	13	174	16	225	21
		76	F.20076.4	9,0	117	13	135	15	171	19	225	25
		89	F.20089.4	7,6	114	15	137	18	167	22	225	30
		102	F.20102.4	6,6	112	17	132	20	172	26	225	34
		115	F.20115.4	5,8	116	20	133	23	168	29	220	38
		127	F.20127.4	5,2	114	22	130	25	166	32	220	43
		140	F.20140.4	4,7	113	24	132	28	165	35	221	47
		152	F.20152.4	4,3	112	26	129	30	163	38	220	51
				305	F.20305.4	2,12	110	52	129	61	161	76

25 - 50 mm Hüsendurchmesser
Rechteckiger Drahtquerschnitt (Fortsetzung)

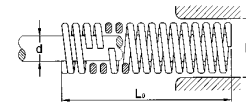

Ø Hülsen mm	Ø Dorn mm	Unbel. Länge mm	Bestell-Nr	Erforderliche daN um Feder 1 mm zu drücken	FEDERWEGE							
					Für lange Lebensdauer (17% von L ₀)		Für mittlere Lebensdauer (20% von L ₀)		Max. Belastbarkeit bei f _n = 25% von L ₀		Federweg bis Blockhöhe	
					C	Kraft daN	Federweg mm	Kraft daN	Federweg mm	Kraft daN	Federweg mm	Kraft daN
25	12,5	32	F.25032.4	35,4	195	5,5	230	6,5	283	8	354	10
		38	F.25038.4	28,0	182	6,5	210	7,5	266	9,5	336	12
		44	F.25044.4	23,2	174	7,5	209	9	255	11	325	14
		51	F.25051.4	19,8	172	8,7	198	10	257	13	317	16
		64	F.25064.4	15,4	169	11	200	13	246	16	316	21
		76	F.25076.4	12,5	163	13	188	15	238	19	313	25
		89	F.25089.4	10,5	158	15	189	18	231	22	310	29
		102	F.25102.4	9,1	155	17	182	20	237	26	310	34
		115	F.25115.4	8,1	162	20	186	23	235	29	310	39
		127	F.25127.4	7,2	158	22	180	25	230	32	310	43
		140	F.25140.4	6,6	158	24	185	28	231	35	317	48
		152	F.25152.4	6,0	156	26	180	30	228	38	310	53
		178	F.25178.4	5,1	153	30	184	36	224	44	310	62
		203	F.25203.4	4,5	153	34	180	40	230	51	310	70
305	F.25305.4	2,96	154	52	181	61	225	76	310	108		
32	16	38	F.32038.4	48,9	318	6,5	367	7,5	465	9,5	558	11
		44	F.32044.4	40,5	304	7,5	365	9	446	11	547	13
		51	F.32051.4	34,6	301	8,7	346	10	450	13	535	15
		64	F.32064.4	26,7	294	11	347	13	427	16	535	20
		76	F.32076.4	21,6	281	13	324	15	410	19	525	24
		89	F.32089.4	18,2	273	15	328	18	400	22	525	29
		102	F.32102.4	15,6	265	17	312	20	406	26	520	33
		115	F.32115.4	13,6	272	20	313	23	394	29	500	36
		127	F.32127.4	12,2	268	22	305	25	390	32	500	41
		140	F.32140.4	11,2	269	24	314	28	392	35	526	47
		152	F.32152.4	10,1	263	26	303	30	384	38	500	50
		178	F.32178.4	8,6	258	30	310	36	378	44	500	59
		203	F.32203.4	7,5	255	34	308	40	383	51	500	68
		254	F.32254.4	6,0	258	43	306	51	384	64	500	85
305	F.32305.4	5,0	260	52	305	61	380	76	500	103		
40	20	51	F.40051.4	56,0	487	8,7	560	10	714	13	840	15
		64	F.40064.4	42,2	464	11	549	13	675	16	820	19
		76	F.40076.4	34,3	446	13	525	15	652	19	815	24
		89	F.40089.4	28,2	423	15	508	18	620	22	800	28
		102	F.40102.4	24,4	415	17	488	20	634	26	800	33
		115	F.40115.4	21,4	428	20	492	23	621	29	792	37
		127	F.40127.4	19,0	418	22	475	25	608	32	780	41
		140	F.40140.4	17,1	410	24	479	28	599	35	787	46
		152	F.40152.4	15,6	406	26	468	30	593	38	780	50
		178	F.40178.4	13,2	396	30	475	36	581	44	765	58
		203	F.40203.4	11,4	388	34	456	40	581	51	765	67
		254	F.40254.4	9,1	391	43	464	51	582	64	765	85
		305	F.40305.4	7,5	390	52	458	61	570	76	760	102
		50	25	64	F.50064.4	72,4	796	11	941	13	1158	16
76	F.50076.4			57,3	745	13	860	15	1089	19	1318	23
89	F.50089.4			47,4	711	15	853	18	1043	22	1280	27
102	F.50102.4			40,4	687	17	808	20	1050	26	1252	31
115	F.50115.4			35,3	706	20	812	23	1024	29	1235	35
127	F.50127.4			31,2	686	22	780	25	998	32	1217	39
140	F.50140.4			28,2	677	24	790	28	987	35	1241	44
152	F.50152.4			25,5	663	26	765	30	969	38	1200	47
178	F.50178.4			21,5	645	30	774	36	946	44	1200	56
203	F.50203.4			18,6	632	34	744	40	949	51	1190	64
254	F.50254.4			14,6	628	43	745	51	934	64	1170	80
305	F.50305.4			12,1	629	52	738	61	920	76	1170	97

Vorgespannte Federn bieten gegenüber ungespannten Federn wesentliche Vorteile :

Jede Feder wird einzeln befestigt und mit der gewünschten Vorspannung versehen.

Beim Zusammenbau des Werkzeuges muß nicht gegen die gesamte Kraft aller Federn gearbeitet werden.

Der Niederhalter wird spannungsfrei von den Hubbegrenzungen gehalten. Daher werden weniger Hubbegrenzungen benötigt.

Zeitersparnis und größere Arbeitssicherheit bei der Montage und Wartung des Werkzeuges.

D1	D2	D3	D4	L1	L2	L3	Bestell-Nr
37	20	16,5	10	48	3	4	FH2
49	25	21,5	13,5	48	4	3	FH3
49	25	21,5	13,5	73	4	3	FH4

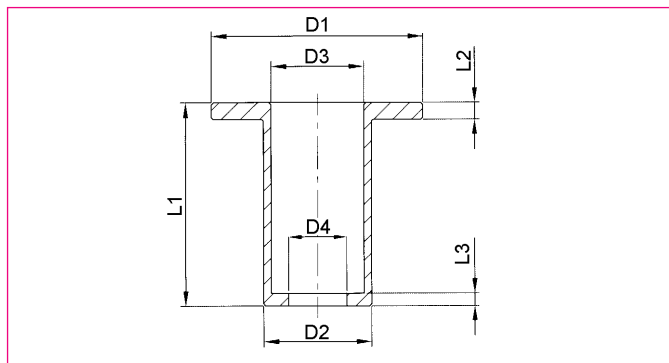

Einbaubeispiele

A Feder vorgespannt mit Federhalter FHx
Passschraube A17.xxx.xxx

B Feder vorgespannt mit Federscheibe Ref. S65.010.xxx
Flex. Zylindr. Passschraube mit Innensechskant A15.xxx.xxx

C Hubbegrenzung mit Flex. Zylindr. Passschraube mit Innensechskant A15.xxx.xxx

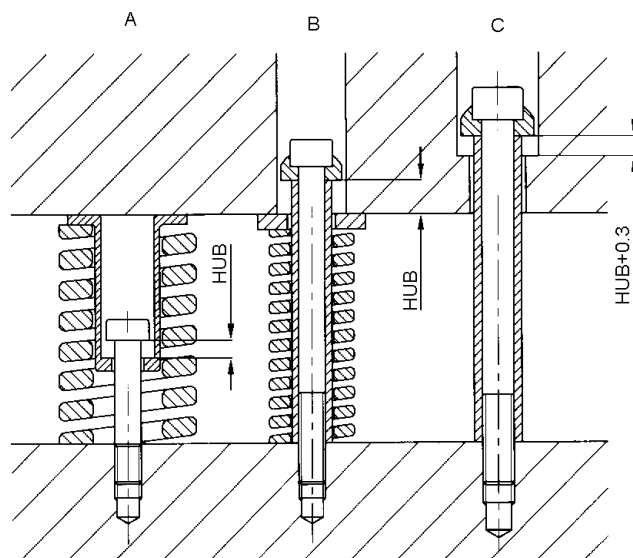



ELASTOMER STÄBE

S66.XXX.XXX
S67.XXX.XXX
S68.XXX.XXX
S69.XXX.XXX

Elastomer-Stäbe sind als Hohl-u. Vollstäbe in zwei Shore A Härten lieferbar.

80 Shore A
 max. Federweg 35%
 Setzneigung 5-7%

90 Shore A
 max. Federweg 30%
 Setzneigung 6-8%

Bestell-Beispiel :
Elastomer Stäbe 80 Shore A D=16 mm L=300 mm
 Bestell-Nr. : **S66.016.300**

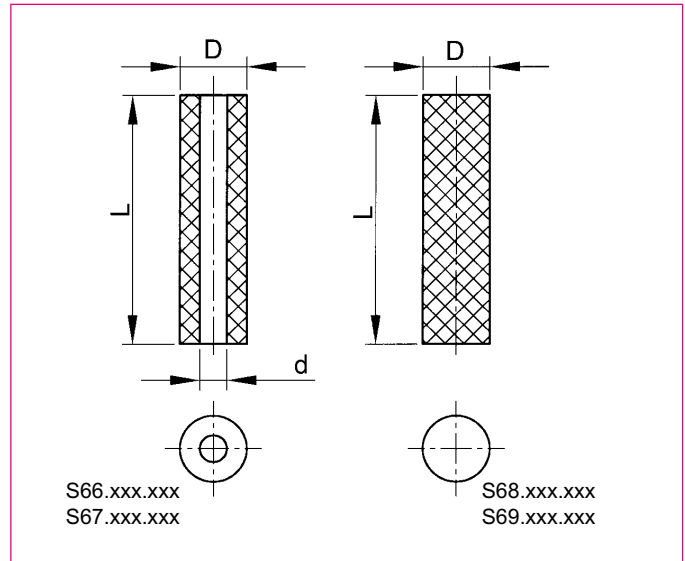

D	d	L	80 Shore A Bestell-Nr. Hohlstäbe	90 Shore A Bestell-Nr. Hohlstäbe
16	6,5	300	S66.016.300	S67.016.300
20	8,5	300	S66.020.300	S67.020.300
25	10,5	300	S66.025.300	S67.025.300
32	13,5	300	S66.032.300	S67.032.300
40	13,5	300	S66.040.300	S67.040.300
50	17	400	S66.050.400	S67.050.400
63	17	400	S66.063.400	S67.063.400
80	21	400	S66.080.400	S67.080.400
100	21	300	S66.100.300	S67.100.300
125	27	300	S66.125.300	S67.125.300

D	L	80 Shore A Bestell-Nr. Vollstäbe	90 Shore A Bestell-Nr. Vollstäbe
16	300	S68.016.300	S69.016.300
20	300	S68.020.300	S69.020.300
25	300	S68.025.300	S69.025.300
32	300	S68.032.300	S69.032.300
40	300	S68.040.300	S69.040.300
50	400	S68.050.400	S69.050.400
63	400	S68.063.400	S69.063.400
80	400	S68.080.400	S69.080.400
100	300	S68.100.300	S69.100.300
125	300	S68.125.300	S69.125.300

Bearbeitungs- hinweise	80 Shore A	90 Shore A
Sägen	+	+
Schneiden	++	++
Bohren spiral	0	+
Bohren hohl	++	++
Drehen	0	+
Fräsen	+	++
Schleifen	+	+
Gewindeschneiden	-	-

Beständigkeit gegen	80 Shore A	90 Shore A
Öl (Schmieröl)	+	+
Fett	+	+
Alkohol	+	+
Waschbenzin	+	+
Wasser	-	-
Ozon	+	+
Laugen	-	-
Säuren	-	-

++ sehr gut + gut 0 zufriedenstellend - bedingt

+ gut - bedingt

Bei Herstellung von Federn in Sonderlängen
 sollte L der Serienfedern nicht überschritten werden



ELASTOMER - FEDERN

70 Shore A

S50.xxx.xxx
Schwarz

Elastomer Federn

Härte : 70 Shore A

Federweg f max. : 40% der Federlänge Lo

Temperaturbeständigkeit : von -20°C bis 80°C

D2 : Ausbauchdurchmesser bei maximalem Federweg f (40%)

Bestell-Beispiel :

Elastomer Feder Ø D1=16 mm Lo=12 mm

Bestell-Nr : **S50.016.012**

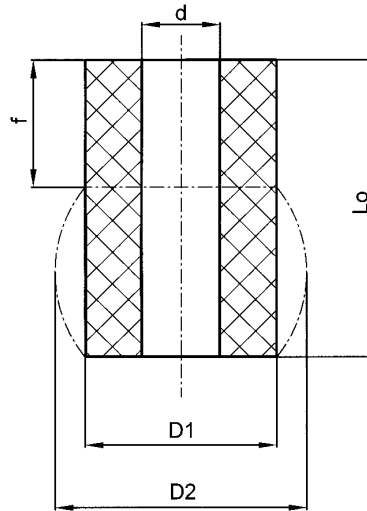

D1	d	D2 fmax	Lo	Bestell-Nr
16	6,5	23	12	S50.016.012
16	6,5	23	16	S50.016.016
16	6,5	23	20	S50.016.020
16	6,5	23	25	S50.016.025
20	8,5	28	16	S50.020.016
20	8,5	28	20	S50.020.020
20	8,5	28	25	S50.020.025
20	8,5	28	32	S50.020.032
25	10,5	35	20	S50.025.020
25	10,5	35	25	S50.025.025
25	10,5	35	32	S50.025.032
25	10,5	35	40	S50.025.040
32	13,5	45	32	S50.032.032
32	13,5	45	40	S50.032.040
32	13,5	45	50	S50.032.050
32	13,5	45	63	S50.032.063
40	13,5	56	32	S50.040.032
40	13,5	56	40	S50.040.040
40	13,5	56	50	S50.040.050
40	13,5	56	63	S50.040.063
40	13,5	56	80	S50.040.080
50	17	70	32	S50.050.032
50	17	70	40	S50.050.040
50	17	70	50	S50.050.050
50	17	70	63	S50.050.063
50	17	70	80	S50.050.080
50	17	70	100	S50.050.100

D1	d	D2 fmax	Lo	Bestell-Nr
63	17	89	32	S50.063.032
63	17	89	40	S50.063.040
63	17	89	50	S50.063.050
63	17	89	63	S50.063.063
63	17	89	80	S50.063.080
63	17	89	100	S50.063.100
63	17	89	125	S50.063.125
80	21	112	32	S50.080.032
80	21	112	40	S50.080.040
80	21	112	50	S50.080.050
80	21	112	63	S50.080.063
80	21	112	80	S50.080.080
80	21	112	100	S50.080.100
80	21	112	125	S50.080.125
100	21	140	32	S50.100.032
100	21	140	40	S50.100.040
100	21	140	50	S50.100.050
100	21	140	63	S50.100.063
100	21	140	80	S50.100.080
100	21	140	100	S50.100.100
100	21	140	125	S50.100.125
125	27	175	32	S50.125.032
125	27	175	40	S50.125.040
125	27	175	50	S50.125.050
125	27	175	63	S50.125.063
125	27	175	100	S50.125.100
125	27	175	125	S50.125.125
125	27	175	160	S50.125.160



ELASTOMER - FEDERN

70 Shore A

S50.xxx.xxx
Schwarz

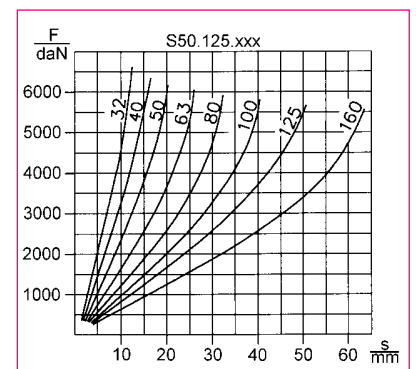
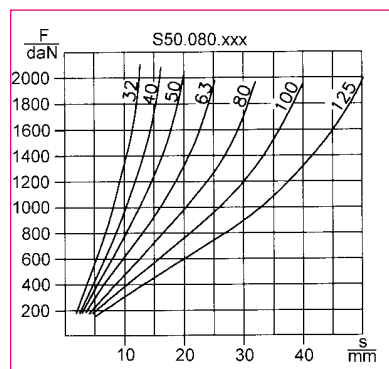
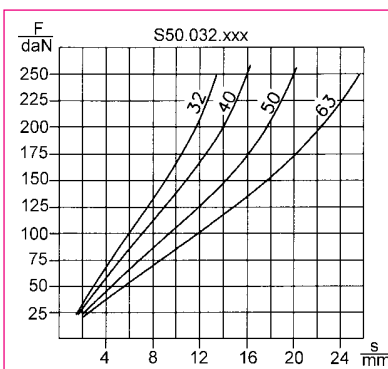
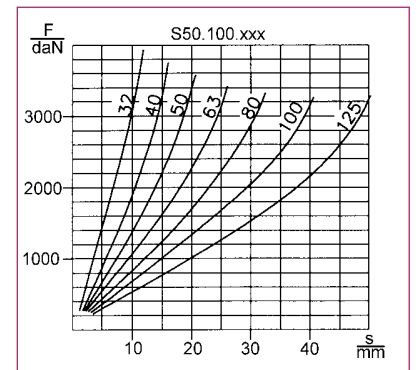
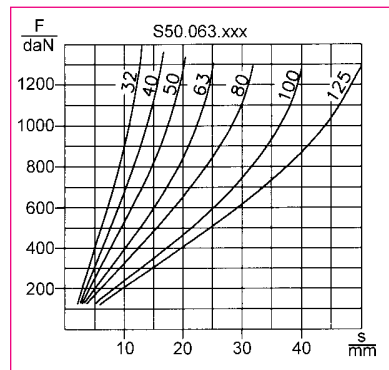
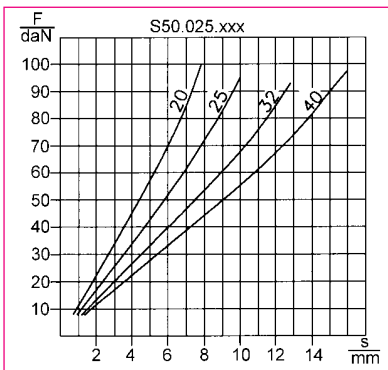
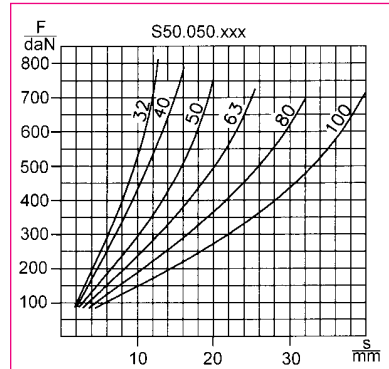
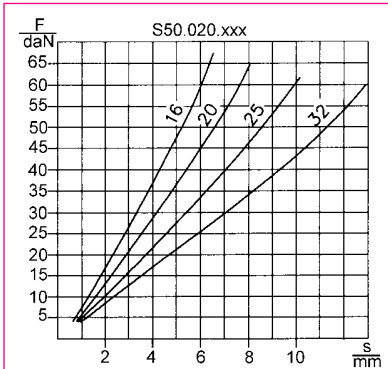
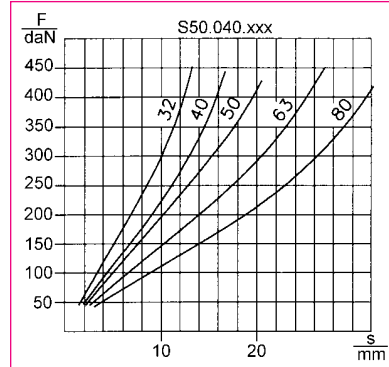
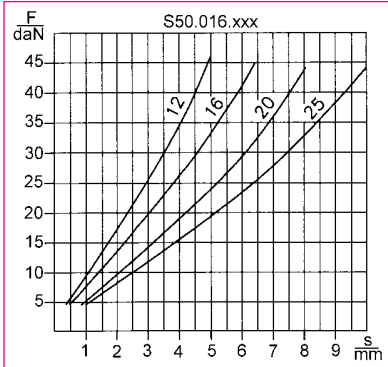



ELASTOMER - FEDERN

90 Shore A

S55.XXX.XXX
Rot

Elastomer Federn

Härte : 90 Shore A

Federweg f max. : 30% der Federlänge Lo

Temperaturbeständigkeit : von -20°C bis 80°C

D2 : Ausbauchdurchmesser bei maximalem Federweg f (30%)

Bestell-Beispiel :

Elastomer Feder Ø D1=16 mm Lo=12 mm

Bestell-Nr : **S55.016.012**

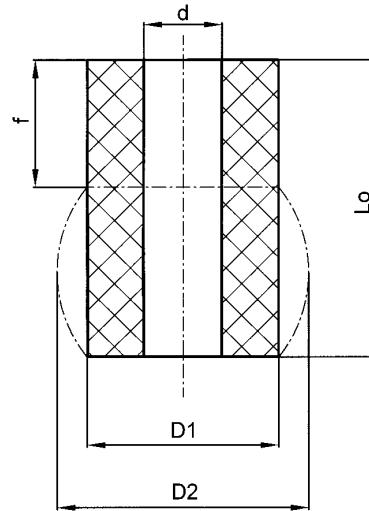

D1	d	D2 fmax	Lo	Bestell-Nr
16	6,5	20	12	S55.016.012
16	6,5	20	16	S55.016.016
16	6,5	20	20	S55.016.020
16	6,5	20	25	S55.016.025
20	8,5	25	16	S55.020.016
20	8,5	25	20	S55.020.020
20	8,5	25	25	S55.020.025
20	8,5	25	32	S55.020.032
25	10,5	30	20	S55.025.020
25	10,5	30	25	S55.025.025
25	10,5	30	32	S55.025.032
25	10,5	30	40	S55.025.040
32	13,5	39	32	S55.032.032
32	13,5	39	40	S55.032.040
32	13,5	39	50	S55.032.050
32	13,5	39	63	S55.032.063
40	13,5	48	32	S55.040.032
40	13,5	48	40	S55.040.040
40	13,5	48	50	S55.040.050
40	13,5	48	63	S55.040.063
40	13,5	48	80	S55.040.080
50	17	60	32	S55.050.032
50	17	60	40	S55.050.040
50	17	60	50	S55.050.050
50	17	60	63	S55.050.063
50	17	60	80	S55.050.080
50	17	60	100	S55.050.100

D1	d	D2 fmax	Lo	Bestell-Nr
63	17	76	32	S55.063.032
63	17	76	40	S55.063.040
63	17	76	50	S55.063.050
63	17	76	63	S55.063.063
63	17	76	80	S55.063.080
63	17	76	100	S55.063.100
63	17	76	125	S55.063.125
80	21	96	32	S55.080.032
80	21	96	40	S55.080.040
80	21	96	50	S55.080.050
80	21	96	63	S55.080.063
80	21	96	80	S55.080.080
80	21	96	100	S55.080.100
80	21	96	125	S55.080.125
100	21	120	32	S55.100.032
100	21	120	40	S55.100.040
100	21	120	50	S55.100.050
100	21	120	63	S55.100.063
100	21	120	80	S55.100.080
100	21	120	100	S55.100.100
100	21	120	125	S55.100.125
125	27	150	32	S55.125.032
125	27	150	40	S55.125.040
125	27	150	50	S55.125.050
125	27	150	63	S55.125.063
125	27	150	80	S55.125.080
125	27	150	100	S55.125.100
125	27	150	125	S55.125.125
125	27	150	160	S55.125.160



ELASTOMER - FEDERN 90 Shore A

S55.xxx.xxx Rot

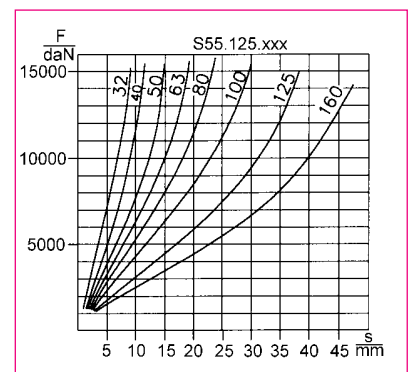
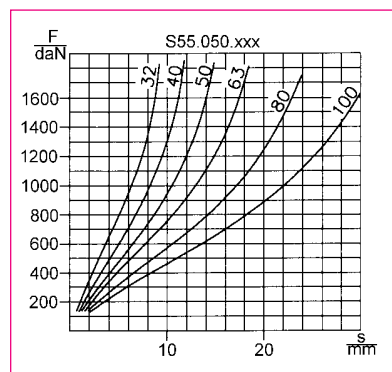
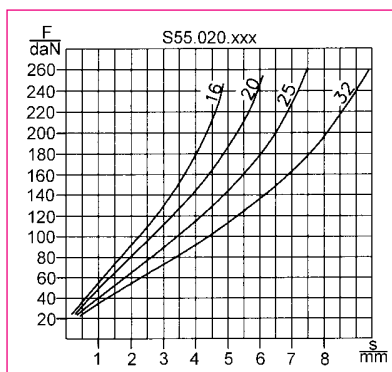
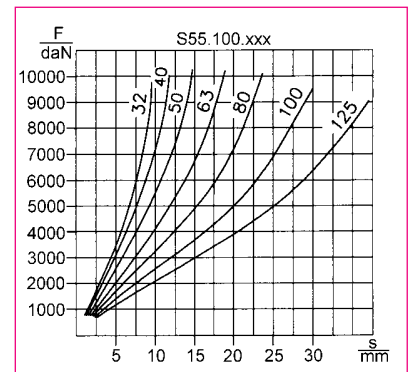
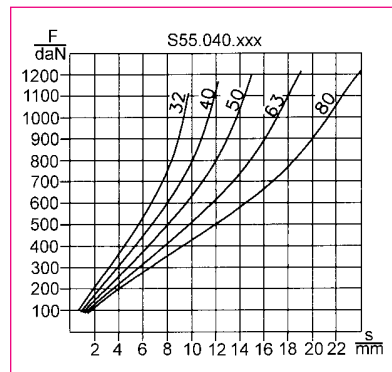
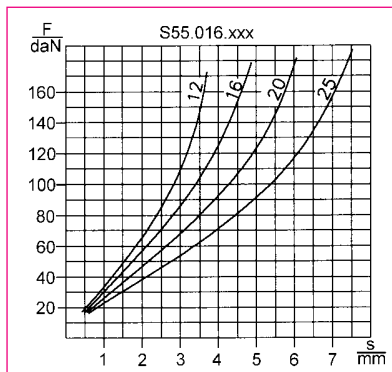
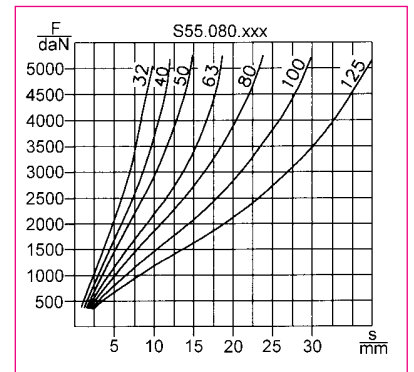
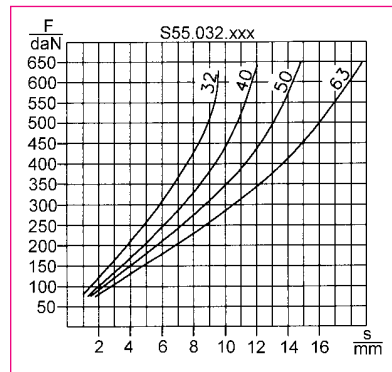
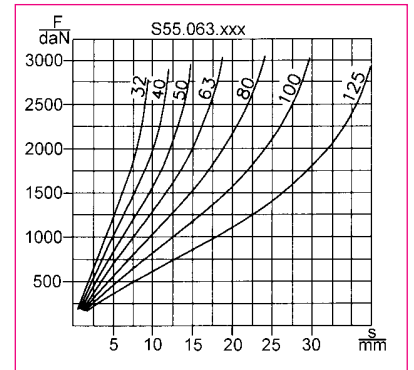
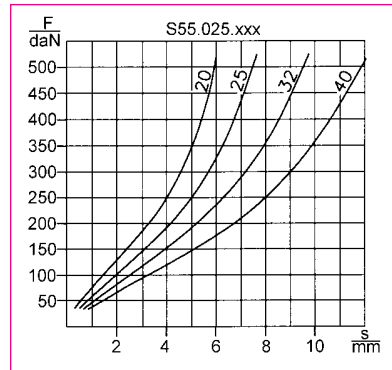



FÜHRUNGSBOLZEN

S60.XXX.XXX

Führungsbolzen
(DIN 9835, Form B)
Nenndurchmesser D

Bestell-Beispiel :
Führungsbolzen $\varnothing D=6$ mm
Länge L1=20 mm
Bestell-Nr : **S60.006.020**

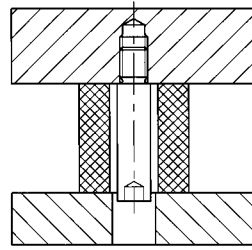

Mit Elastomer-Feder

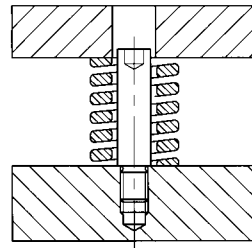

Mit Schraubendruckfeder

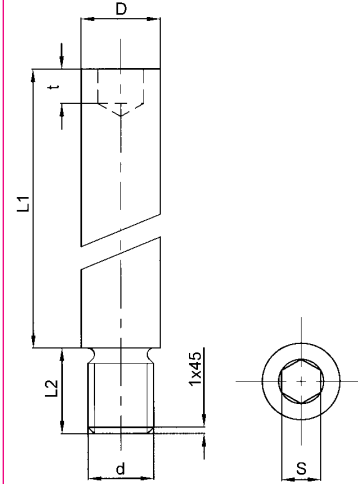

D	6	8	10	13	16	20	25	
d	M4	M6	M8	M10	M12	M16	M20	
L2	6	9	15	15	18	25	30	
s	3	4	5	6	8	10	14	
t	2,5	3	4	5	6	8	10	
L1	20	S60.006.020	S60.008.020	S60.010.020				
	25	S60.006.025	S60.008.025	S60.010.025				
	32	S60.006.032	S60.008.032	S60.010.032	S60.013.032	S60.016.032	S60.020.032	S60.025.032
	40		S60.008.040	S60.010.040	S60.013.040	S60.016.040	S60.020.040	S60.025.040
	50		S60.008.050	S60.010.050	S60.013.050	S60.016.050	S60.020.050	S60.025.050
	63			S60.010.063	S60.013.063	S60.016.063	S60.020.063	S60.025.063
	80				S60.013.080	S60.016.080	S60.020.080	S60.025.080
	95				S60.013.095	S60.016.095	S60.020.095	S60.025.095
	118					S60.016.118	S60.020.118	S60.025.118
	140					S60.016.140	S60.020.140	S60.025.140
180							S60.025.180	



FEDERSCHEIBEN

S65.010.XXX

Nach DIN 9835, Form A.

Bestell-Beispiel :
Federscheibe $\varnothing D=20$ mm
Bestell-Nr : **S65.010.020**

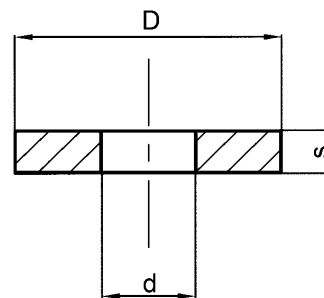

D	20	25	30	40	50	60	80	100	120	150
d	6,5	8,5	10,5	13,5	13,5	16,5	16,5	20,5	20,5	26
9	4	4	5	5	5	6	6	8	8	8
Bestell-Nr	S65.010.020	S65.010.025	S65.010.030	S65.010.040	S65.010.050	S65.010.060	S65.010.080	S65.010.100	S65.010.120	S65.010.150

Vorgespannte Federn bieten gegenüber ungespannten Federn wesentliche Vorteile:

Jede Feder wird einzeln befestigt und mit der gewünschten Vorspannung versehen.

Beim Zusammenbau des Werkzeuges muß nicht gegen die gesamte Kraft aller Federn gearbeitet werden.

Der Niederhalter wird spannungsfrei von den Hubbegrenzungen gehalten. Daher werden weniger Hubbegrenzungen benötigt.

Zeitersparnis und größere Arbeitssicherheit bei der Montage und Wartung des Werkzeuges

Einbaubeispiele

- A Feder vorgespannt mit
Federscheibe S65.xxx.xxx
Flex. Zylindr. Passschraube
mit Innensechskant
A15.xxx.xxx
- B Hubbegrenzung mit
Flex. Zylindr. Passschraube
mit Innensechskant
A15.xxx.xxx

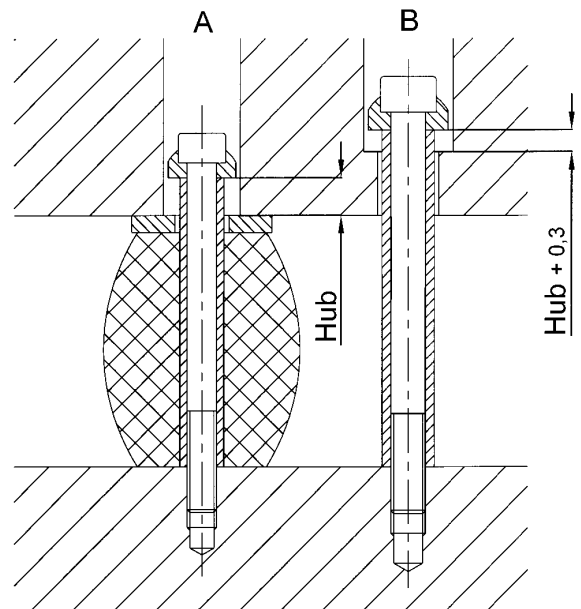

Platzbedarf

Bei einem Außendurchmesser D1 von 50 mm beträgt bei 27% Zusammendrückung gem. Diagramm der ausbauchfaktor ca. 1,27.

Damit beträgt der Ausbauchdurchmesser D2 ca. 63,5 mm.

Das Einbaumaß sollte in diesem Fall hinsichtlich des Sicherheitsfreiraumes nicht kleiner als 65 mm sein.

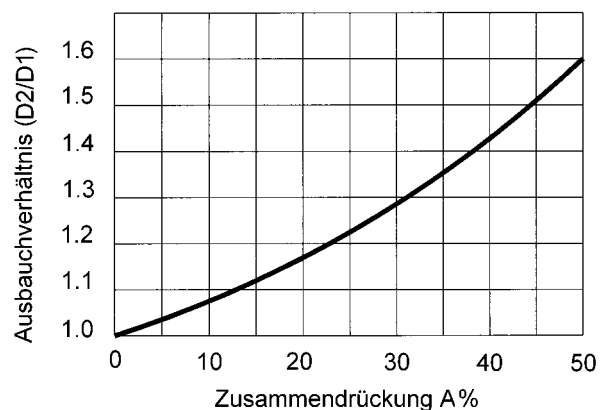



FRANCE

MDL
Rue de l'Oberwald
68360 SOULTZ
✉ BP 126 - 68503 GUEBWILLER CEDEX
Tél. : +33 (0)3 89 74 24 24
Fax : +33 (0)3 89 76 49 99
E-Mail : mdlrodis@mdl-rodiss.com

PORTER-BESSON S.A.S.
2, rue Paul Appell - Z.I. du Vert-Galant
95310 SAINT-OUEN-L'AUMÔNE
✉ BP 97725 - 95046 CERGY CEDEX
Tél. : +33 (0)1 34 40 27 00
Fax : +33 (0)1 34 40 27 09
E-Mail : porter-besson@mdl-rodiss.com

GERMANY

MDL - RODIS GmbH
Lammertstrasse 15-19
63075 OFFENBACH
Tel. : +49 (0)69 830 0688-0
Fax : +49 (0)69 866 294
E-Mail : mdl-verkauf@mdl-rodiss.com

BRAZIL

MÁQUINAS DANLY LTDA
Rua Dom Villares, 1680
CEP 04160-1 SÃO PAULO, SP
Tél. : +55 11 6948 9220
Fax : +55 11 6948 9215
E-Mail : vendasp@mdl-danly.com.br

MEXICO

MDL DE MEXICO SA DE CV
Conjunto Victoria II
Acceso III No 52 Bodega 19
Zona Industrial Benito Juarez
CP 76120 QUERETARO
Tél. : +52 442 210 0020
Fax : +52 442 210 0012
E-Mail : ventas@mdlmexico.com.mx

U.S.A.

Mold & Die Components Inc.
4520 Progress Dr.
Columbus, IN 47201
Tél. : (812) 373-0021
Fax : (812) 373-0042
E-Mail : sales@mdlusa.com